



# DEFENSE PROFILE



**COMROD**  
*Reaching further*



# REACHING FURTHER

COMROD is a multinational group of companies with locations in Norway, France, Sweden, Hungary, and the USA.

Since 1948, COMROD has grown through a dedication to innovation in research, development, and manufacturing. This dedication has earned COMROD a global reputation for quality and performance.

## Antenna Overview

- Vehicle Antennas
- Handheld Antennas
- Manpack Antennas
- Ground-Deployed Antennas
- Shipboard Antennas
- Submarine Antennas
- Antenna Combiners
- Antenna Control Systems

## Mast Overview

- Telescopic Aluminum Masts
- Telescopic Composite Masts
- Tripod Sectional Masts
- Man-Portable Composite Masts
- Mast Payload Alignment Solutions

## Power Supply Overview

- AC/DC Converters
- DC/AC Inverters
- DC/DC Conditioners
- Dual AC/DC & DC/DC Converters
- Battery Chargers

## Mission Planning Software Overview

- Tactical Communications Tool (TCT)
- Sensor Planning Tool



# ANTENNA OVERVIEW

Our customers demand reliable communications. We provide the performance and reliability they can trust. COMROD's field-proven antennas have earned a reputation in the industry for innovative engineering and unmatched quality.



**VEHICLE ANTENNAS**



**MANPACK ANTENNAS**



**GROUND DEPLOYED ANTENNAS**



**SUBMARINE ANTENNA SYSTEMS**



**ANTENNA REDUCTION & OPTIMIZATION SYSTEMS**



**HANDHELD ANTENNAS**



**SHIPBOARD ANTENNAS**



## VEHICLE ANTENNAS

Defense customers around the world turn to COMROD for innovative antenna solutions for their vehicle platforms. Solving complex vehicle integration with the latest antenna technology is our strength. MIL-STD-810G ruggedized, single-band and multi-band solutions from 1.6 MHz to 6 GHz

### Featured Products:



#### **HF Loop (HF230L-OTM):**

- HF: 1.6-30 MHz
- HF communication On-The-Move (OTM)
- Groundwave, NVIS, & Skywave
- Adapts the impedance for high efficiency tuning by the coupler



#### **High Isolation Tri-band (VHF302600TB-F):**

- VHF: 30-88 MHz, UHF: 225-450 MHz, L-S Band: 1200-2600 MHz
- High isolation between bands
- L1/L2 GPS option
- NATO 4-hole flange base with spring
- UHF and L-S Band elements located high in the antenna for maximum range



#### **UHF MUOS & Legacy SATCOM Antenna (UHF243380S):**

- MUOS: 300-320/360-380 MHz
- UFO: 292-318/243-270 MHz
- Quadrifilar Helix
- No groundplane required
- NATO 4-hole flange base
- Radiating element removable from the base

# ANTENNA REDUCTION & OPTIMIZATION SYSTEMS

Antenna reduction and optimization solutions simplify your installation, freeing platform space while reducing the visual signature. Diplexers, Triplexers, Combiners, and Antenna Control Systems (ACS) reduce co-site interference while maximizing system performance.

## Featured Product:



### Antenna Multi-Combiner (ACS018):

- Antenna Ports: 2 x 30-512 MHz, 2 x 30-2700 MHz
- Radio Ports: 4 x 30-88 MHz, 2 x 225-450 MHz, 2 x 225-512 MHz, 2 x 700-2700 MHz
- Simultaneous transmission on all ports
- High isolation between ports
- Designed to fit standard 19 inch rack. 1U tall, half-rack width
- Highly flexible design can be configured to meet specific platform and frequency requirements

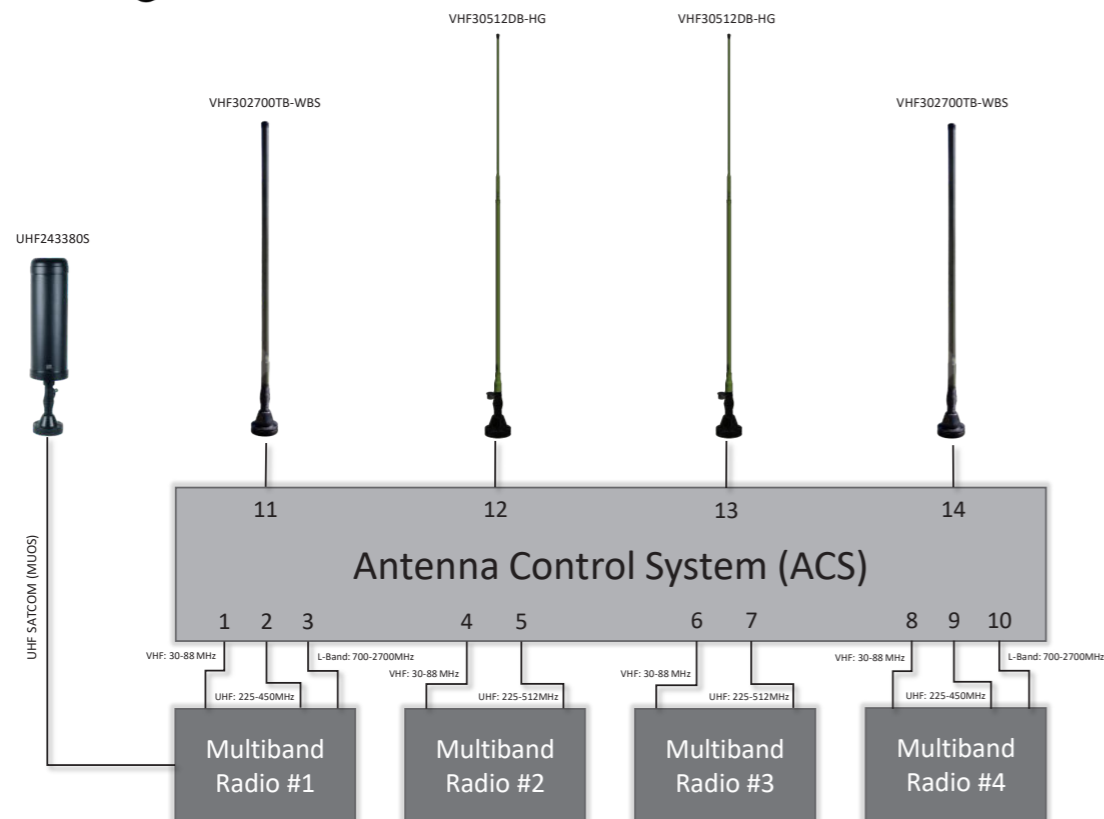



## MANPACK & HANDHELD ANTENNAS

COMROD has been delivering high-performance, rugged manpack and handheld antennas to the world's top defense customers for decades. With antenna solutions covering 1.6-2600 MHz, COMROD has the right antenna for legacy and modern software defined radios.

### Featured Products:



#### Dual band UHF / L-S Band Handheld Antenna (UHF2252600DB-HH):

- Dual-band UHF and L-S Band
- UHF: 225-450 MHz
- L-S Band: 700-2600 MHz
- UHF monopole, L-S Band dipole design
- Small form factor only 30 cm long
- Power rating 5 W CW, 25 W PEP



#### VHF/UHF Wideband Roll-Up Dipole Antenna (VHF30512UCD):

- VHF/UHF: 30-512 MHz
- Unique roll-up man-portable design packs down into a single small bag
- Throwing cord for deployment using available structures or trees
- Can be supported with a manpack mast like the 5.4 m COMROD AMX54



#### UHF Manpack Dipole Antenna (UHF225450MP-D-F-TNC):

- UHF 225-450 MHz
- Dipole design
- Additional filtering for high isolation between UHF and neighboring VHF frequency band
- Flexible top blade and gooseneck
- 20 W Power rating

# GROUND-DEPLOYED ANTENNAS

COMROD has a long history of supplying tactical ground-deployed antenna solutions. Whether you need to elevate, or rapidly ground deploy the antenna at-the-halt, COMROD offers multiple products covering 1.6 MHz to 6 GHz

## Featured Products:

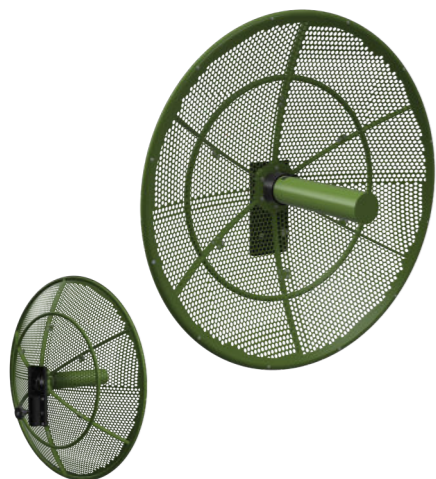

### **Band IV Radio Relay (LOS) Dual-Polarized Dish (SHF4459P09):**

- Band IV frequency: 4.4 –5.875 GHz
- Dual polarised +/- 90° (H & V)
- Designed for line-of-sight (LOS) and high capacity line-of-sight (HCLOS) radio relay communications
- High gain
- Removable feed for protection and easy transportation



### **Elevated Tri-band & HF Antenna Mast System (ETAMS-HF):**

- Man-portable elevated antenna system with 8.5 m mast
- Antenna frequency range:
  - HF: 1.6-30 MHz
  - VHF: 30-88 MHz
  - UHF: 225-450 MHz
  - L-S band: 1200-2600 MHz
- Supports legacy and modern networking waveforms
- COMROD tri-band antenna (VHF302600TB) installed on top of mast. COMROD HF wire dipole antenna (HF230XD-BF) installed at lower guy position
- Kit includes standard lower guy lines when HF antenna is not required
- Complete kit supplied in one compact bag
- System can be deployed in less than 15 minutes





## SHIPBOARD ANTENNA SYSTEMS

COMROD has been producing high quality antennas for the harshest marine environments since the 1960's. Our shipboard antennas can be found on vessels worldwide and have become the trusted source in demanding applications. Today, COMROD continues to introduce cutting-edge antenna technology to the world's naval surface vessel fleets.

### Featured Products:

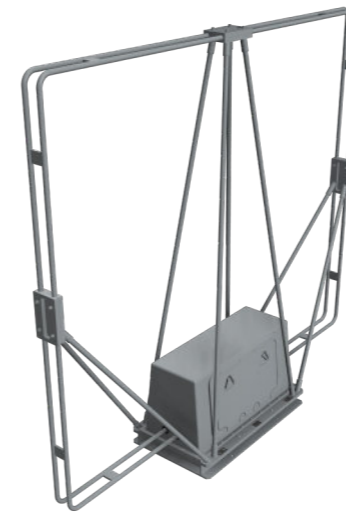

#### **Naval HF NVIS Loop Antenna (HF230L-N):**

- Compact HF antenna for naval platforms
- HF: 1.6-30 MHz
- Continuous communication in Groundwave, NVIS and Skywave
- Superior Near Vertical Incident Skywave (NVIS) performance
- Cost effective, compact installation compared to existing HF naval NVIS solutions
- Power Rating: 500 W PEP



#### **High Power Passive Transformer (AT-T1K):**

- Designed for use with COMROD 10 m side feed whips
- HF: 1.6-30 MHz
- 50 ohm, N type female connector
- 1 KW PEP
- Broadband - no tuning
- Gain comparable to a commercial maritime tuner and whip
- Reduced cabling - no DC power required





# SUBMARINE ANTENNA SYSTEMS

Submarines are subjected to the most demanding and challenging maritime environment. COMROD designs and manufactures antenna systems that meet the challenge of that environment. Our sophisticated submarine antenna solutions deliver high efficiency in small form factors.

## Featured Products:



### **Fast Tuning HF Antenna System (HF1830S):**

- HF: 1.8-30 MHz
- High power: Up to 1000W PEP
- Fast tuning: 3 ms
- Flexible: Standalone or integration to radio system
- Silent tuning: Tuning without tune power
- State of the art: Designed for 3G-ALE having wide and narrowband modes
- Designed for safety: Compatible with GMDSS MF/HF systems

### **Multi-Function Wideband Antenna System (MFA303000S-K):**

- Wide coverage: 30-3000 MHz both Tx (selected bands) and Rx
- Highly customizable antenna configuration
- Multi mode: satisfies the need for LoS and Beyond-LoS communication
- Modular: constructed from proven antenna elements that can be exchanged if other needs arise
- Compact: high efficiency in a small form factor, given the number of functions/bands





# MAST OVERVIEW

COMROD is a major supplier of mast solutions for elevating payloads. Telescopic, tripod sectional, and man-portable masts. Regardless of the payload you need to elevate, we have reliable, safe, and efficient solutions.



TELESCOPIC ALUMINUM MASTS

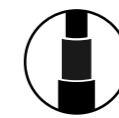

TELESCOPIC COMPOSITE MASTS



TRIPOD SECTIONAL MASTS



MAN-PORTABLE SECTIONAL MASTS



MAST PAYLOAD  
ALIGNMENT SYSTEMS



## TELESCOPIC MASTS

Our aluminum TM and composite LMT series of telescopic masts are deployed by hand crank winch, electrical winch or built-in motor drive. MIL-STD qualified and field-proven, our aluminum and composite telescopic masts are designed to stand the test of time. Deployed heights up to 30 m.

### Featured Products:



#### Aluminum Telescopic Mast Series (TM Series):

- Heights up to 30 m
- Heavy payload capability on larger masts
- Hand cranked manual winch, electrically driven winch, or built-in motor drive
- Configuration options for nested vs extended heights
- Manufactured from lightweight hexagonal aluminum sections



#### Composite Telescopic Mast Series (LMT Series):

- Fully deployed, un-guyed heights up to 15 m
- Qualified to MIL-STD-810G, MIL-STD-461E, MIL-STD-1275E
- Capable of supporting heavy payloads
- Rigid mast for payloads such as EO/IR systems, cameras, sensors, and antennas requiring high pointing accuracy
- Cable management options for routing payload cables inside or outside mast
- Baseplate interface for platform integration

## TRIPOD SECTIONAL MASTS

COMROD's line of tripod sectional masts are unrivaled for ruggedness, efficiency, and safety. Our Heavy-Duty, Medium-Duty, and Light-Duty masts can reach heights of 34 m. Their composite design make them ultra-light and extremely durable while being capable of lifting payloads up to 130 kg.

### Featured Products:



#### Sectional Tripod Mast (ULM Series):

- Fully deployed heights of 10, 15, 20 & 24 m
- Lightweight carbon composite sleeve masts capable of supporting payloads up to 80 kg
- The tripod support includes a lifting mechanism and hoist to raise each section
- Can be deployed by two operators in 20 minutes or three operators in 15 minutes
- Particularly suited to supporting line-of-site (LOS), directional, omni-directional, or wire antennas, and optronic equipment and sensors



#### Sectional Tripod Mast (MLV Series):

- Fully deployed heights of 10, 15, 20, 30 and 34 m
- Heavy duty composite sectional tripod masts capable of supporting payloads up to 130 kg
- The tripod includes a manual or electric lifting mechanism and hoist to raise each section
- Central guying system enables the guy tension to be maintained by a single operator during deployment of the mast
- 2 or 3 operators can deploy the mast even in high winds
- 360 degree azimuth rotation from the ground to orientate the top load

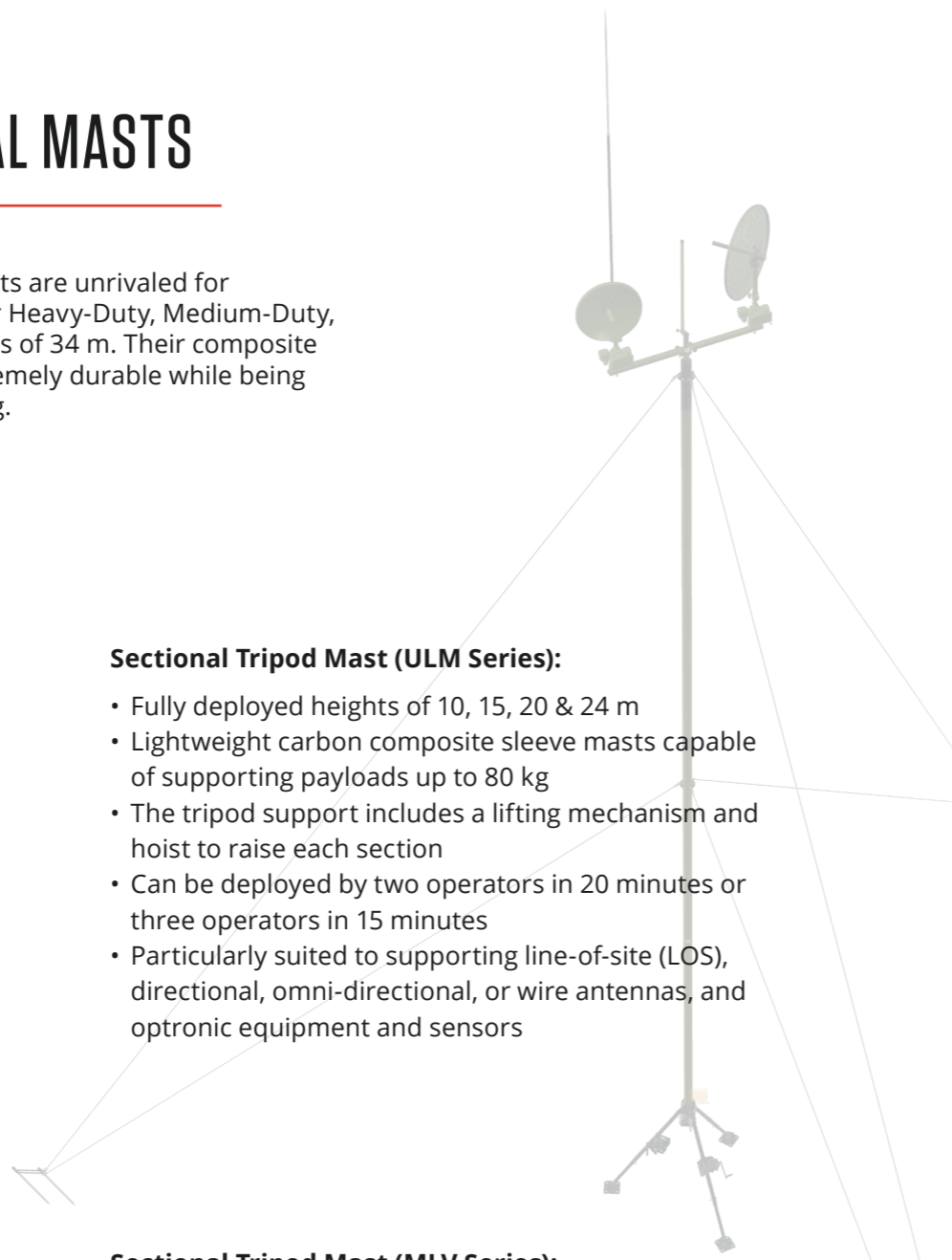



## MAN-PORTABLE SECTIONAL MASTS

COMROD has a range of man-portable mast solutions to quickly deploy lighter payloads. Made of lightweight composite materials, these masts can easily be deployed by one or two operators in a matter of minutes.

### Featured Products:

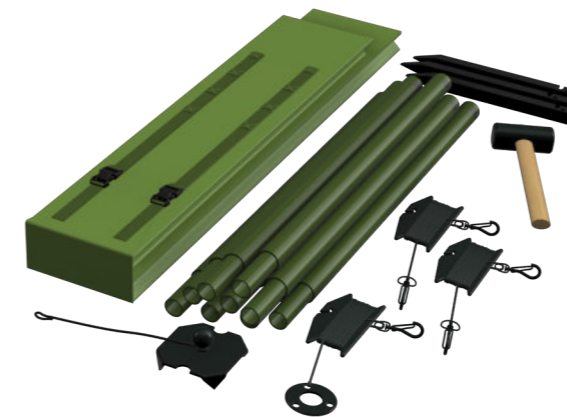

#### Man-Portable Sectional Mast (AMX54):

- Fully deployed height of 5.4 m
- Top payloads up to 3 kg
- 9 lightweight composite sections, 0.6 m (24 in) long
- Single level, three way guy ropes
- Packs down into a single, easy to carry bag
- Quickly and easily deployed by a single person

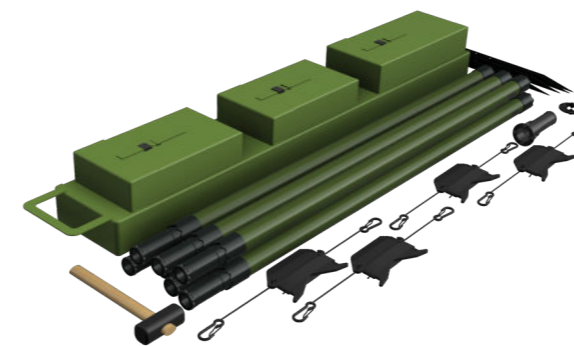

#### Man-Portable Sectional Mast (AMX85):

- Fully deployed heights of 8.5 m
- Top payloads up to 4 kg, or 6 kg with optional lower guy kit
- Quickly and easily deployed by a single operator
- Mast sections fit together to lock azimuth rotation, enabling the use of directional antennas
- Single level, four way guy ropes
- Packs down into a single, easy to carry bag



# MAST PAYLOAD ALIGNMENT SYSTEMS

The COMROD family of CAPAS® Automatic Payload Alignment Systems are designed to meet the challenges faced by today's defense and public safety users. CAPAS® systems enable quick and effective deployment of communication or sensor assets in extreme environments without exposing personnel to unnecessary danger.

## Featured Products:



### COMROD Automated Payload Alignment System Rotator Tilter (CAPAS-RT):

- Computer controlled +/- 15° tilt, and 360° rotation of payloads
- Powerful drive system coupled with the integrated magnetic compass ensures fast and accurate positioning
- Supports both closed loop and open loop alignment, or a combination of both
- In closed loop alignment mode, the system is controlled by a radio transceiver to optimize received signal strength and minimize bit error rate
- In open loop mode, the system can utilize input from the COMROD TCT Planning Software for quick initial positioning
- Closed loop feedback from the radio can then further optimize the alignment within a fraction of a degree
- Fully rugged per MIL-STD-810G
- Suitable for deployment on a wide range of COMROD masts including TM, LMT, ULM & MLV series



### Manual Rotator Tilter:

- Manual (dual rope) controlled +/- 10° tilt, and 360° rotation of payloads
- Precise alignment possible within a fraction of a degree
- Fully rugged per MIL-STD-810G
- Suitable for deployment on a wide range of COMROD masts including TM, LMT, ULM & MLV series





# MISSION PLANNING SOFTWARE OVERVIEW

COMROD's Tactical Communication Tool (TCT) is a planning software that allows planners to take the guesswork out of tactical communication deployment. The full-spectrum tool allows time based planning, geographical network planning, and link propagation analysis.



## MISSION PLANNING SOFTWARE

### Featured Product:

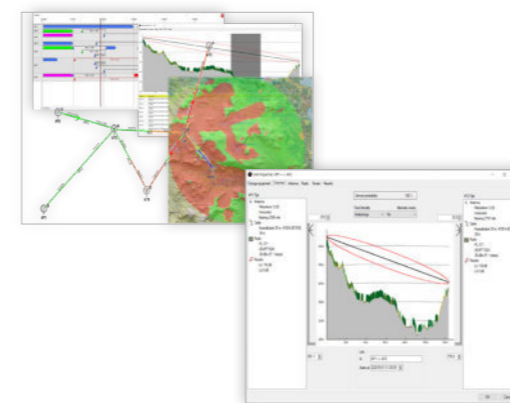

#### Tactical Communication Tool (TCT):

- Time based planning
- Inventory management
- Tactical radio planning and analysis of coverage
- Radio path calculations
- LTE link budget and coverage calculations with expected bandwidth results
- Point-to-multipoint planning
- Rapid possible links calculations
- Frequency planning
- Satellite communication
- Radio coverage calculation
- Planning of gateway and transit connections
- Configurable equipment
- Frequency conflict calculations for radio links
- Order creation
- Equipment resources management
- Interfacing for network monitoring
- Order of battle overlay handling
- Visualization of antenna radiation patterns
- Supports a broad range of geographical data formats and customization of vector maps
- Co-planning with multi user support
- Planning with relays
- Enhanced conflict management
- Enhanced adaptive output power calculations
- Enhanced event view and event management
- Better support for customized appearance and translation
- Import new inventory



## POWER SUPPLIES & BATTERY CHARGERS

### Featured Products:



#### 2400 W Power Supply and Battery Charger (ComPact 2400 AC/DC):

- Input: 120/230 VAC, 50/60/400 Hz
- Output: 5-34 VDC, 80 A, 2400 W
- MIL-STD-810G, MIL-STD-461G, MIL-STD-1275D
- Power Factor Correction (PFC)
- RS-485 bus
- Active load sharing
- Battery temperature compensated charging
- IP67
- Stand-alone or mounted in a 19" rack

#### 2000 VA Inverter (ComPact 2000 DC/AC):

- Input: 16-34 VDC
- Output: 120/230 VAC pure sine, 50/60 Hz, 2000VA
- MIL-STD-810G, MIL-STD-461G, MIL-STD-1275E
- RS-485 bus (CAN bus available with future firmware upgrade)
- Protected from overvoltage, overcurrent, short circuit, reversed input polarity and over temperature
- IP67
- Stand-alone or mounted in a 19" rack

# POWER SUPPLY OVERVIEW

COMROD'S power supply and battery charging solutions are second to none. Fully ruggedized, unrivaled power density, and software defined, our power products have revolutionized the defense market.





**Comrod Communication AS**

Fiskaavegen 1, N-4120, Tau, Norway

[sales@comrod.com](mailto:sales@comrod.com)

[www.comrod.com](http://www.comrod.com)